

# 5-Waves chair series

Designed by ISKOS-BERLIN

for Harvest-One

2016

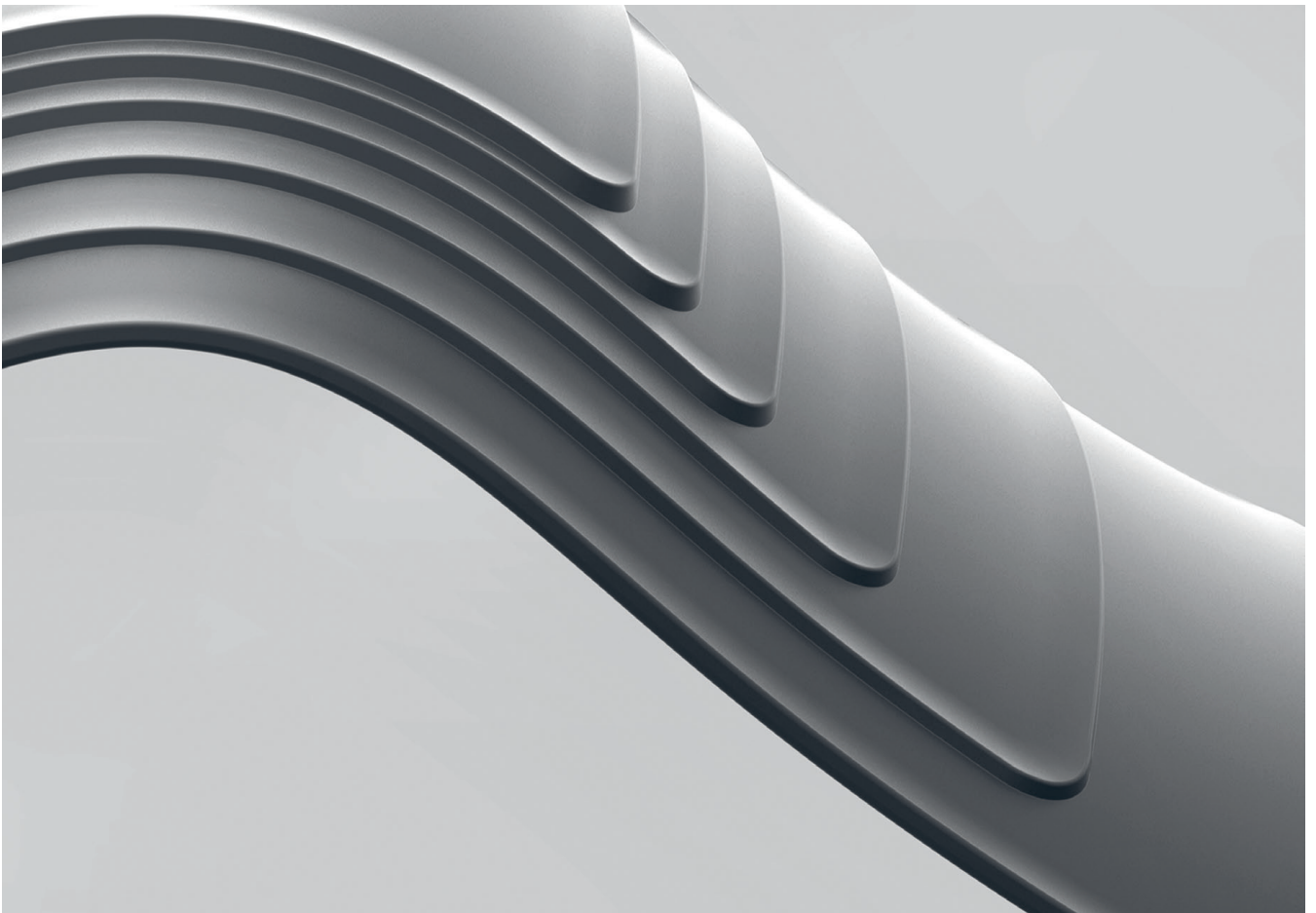



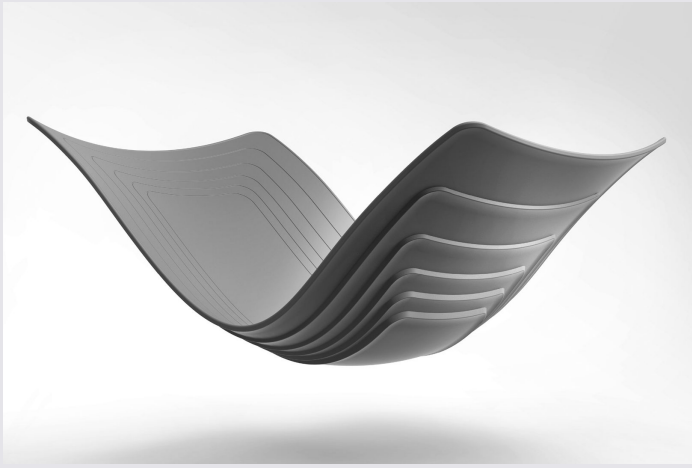

# harvest one

Harvest-One is a brand resulting from cooperation between the Danish design studio **ISKOS** — **BERLIN** and the Taiwanese office furniture manufacturer, Harvest Link International – the best of Danish design meets the best of Taiwanese industrial production.

The 5-Waves chair series is the first “harvest” of this fertile collaboration across seas, cultures, and traditions ...

## 5-Waves chair series

---

4



The 5-Waves chair series is designed with an extensive range of frames, offering a comprehensive product line for several segments of the contract market.



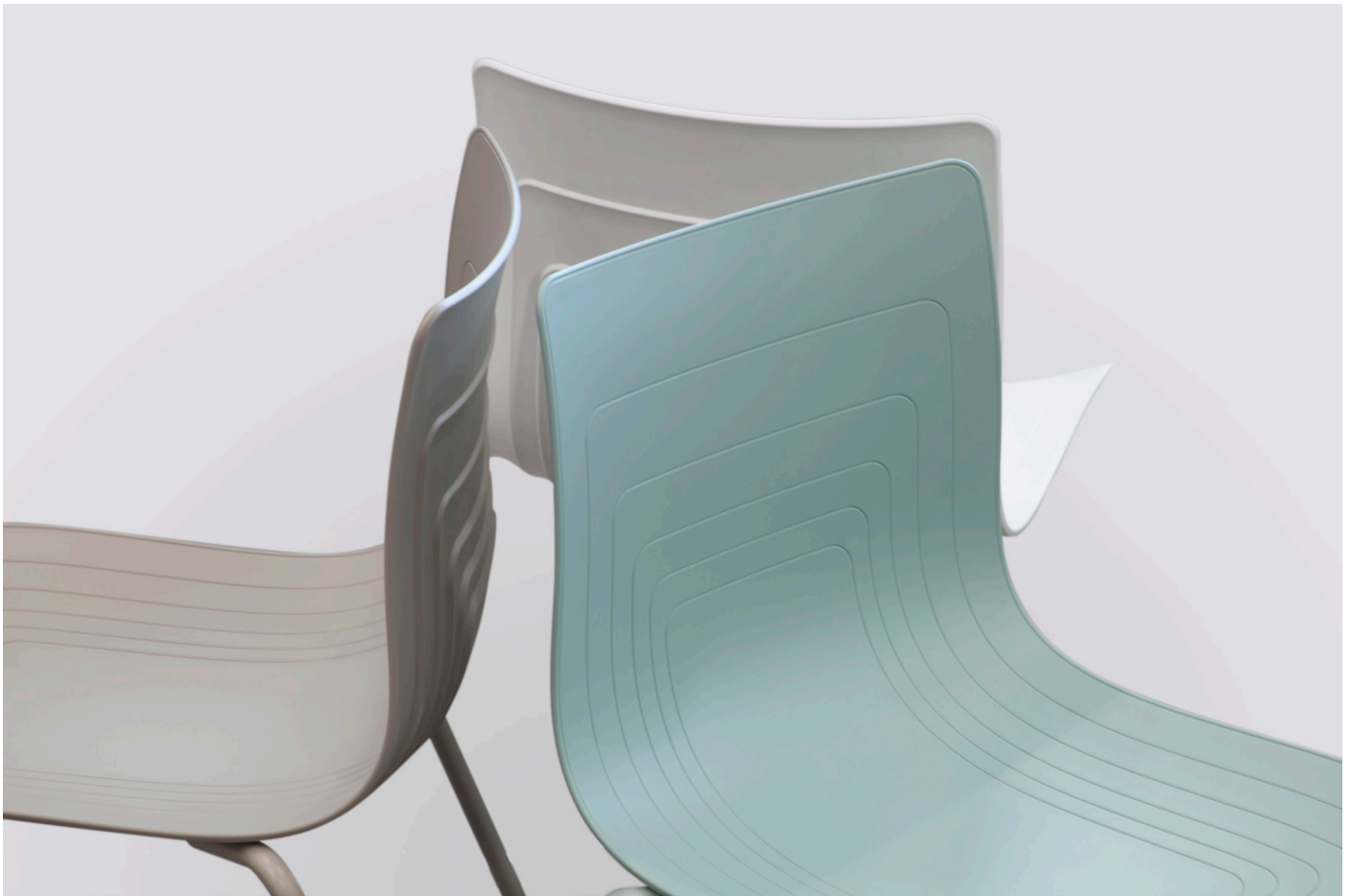

The main element of the 5-Waves chair design is its innovative injection-molded shell with dynamic seating comfort – supporting the body without restricting its movement.

5-Waves' shell has 5 zones, or "waves", each with its own distinct properties:

the first "wave" provides rigidity– it is purely structural;  
the second "wave" transitions between the structural zone and springy zones;

the third "wave" offers support for the pelvis and lower back;

the fourth "wave" provides springy dynamic support;  
the fifth "wave" is an elastic outer zone reducing unnecessary pressure on the soft tissues of the body.



**5-Waves**  
chair series

---







**5-Waves**  
chair series

---



10



**5-Waves**  
chair series

---



12



**5-Waves**  
chair series

---



14



**5-Waves**  
chair series

---







**4-Waves**  
chair series

---





# 4 -Waves



20

# 6 -Waves



# The Collection

## 5-WAVES CHAIR

Four legs chair  
5W-1-PP

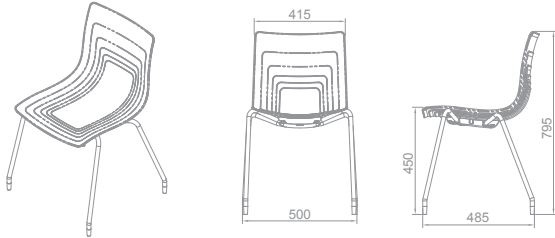

## 5-WAVES CHAIR

Four legs chair with armrest  
5W-1L-PP

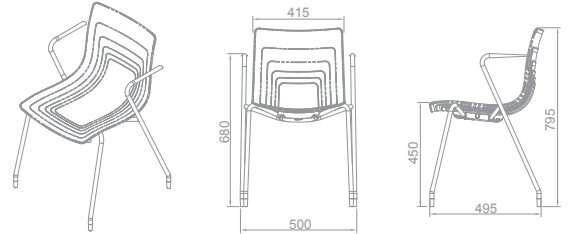

## 5-WAVES CHAIR

Four legs chair with casters  
5W-1C-PP

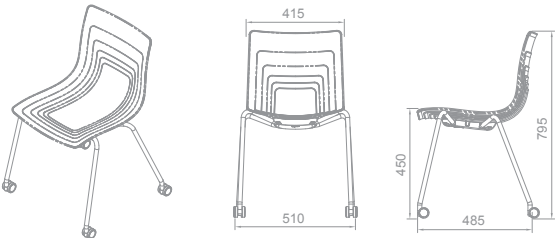

## 5-WAVES CHAIR

Four legs chair with writing tablet  
5W-1-PP+WR

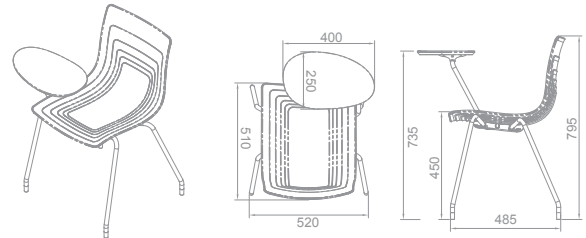

## 5-WAVES CHAIR

Sled base chair  
5W-2-PP

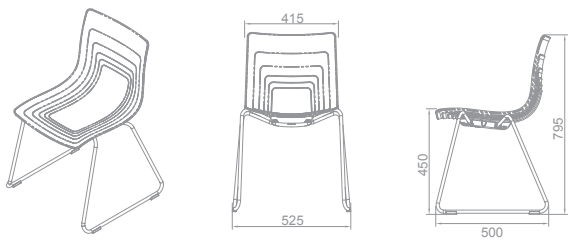

## 5-WAVES CHAIR

Sled base chair with armrest  
5W-2L-PP

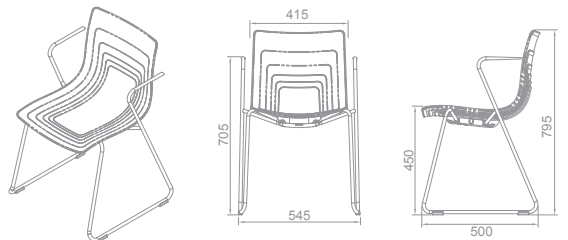

## 5-WAVES CHAIR

Swivel base with casters  
5W-4-PP-AP1

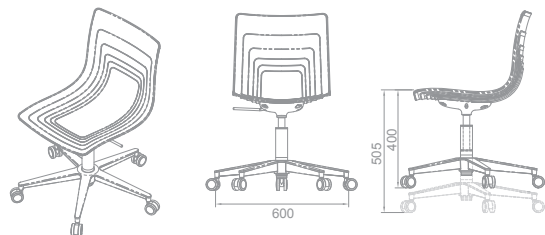

## 5-WAVES CHAIR

Swivel base with casters and arm  
5W-4L-PP-AP1

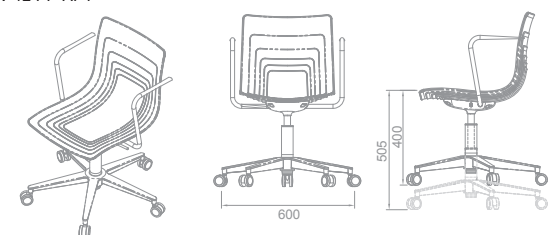

# The Collection

## 5-WAVES CHAIR

Plywood base chair  
5W-3PW-PP

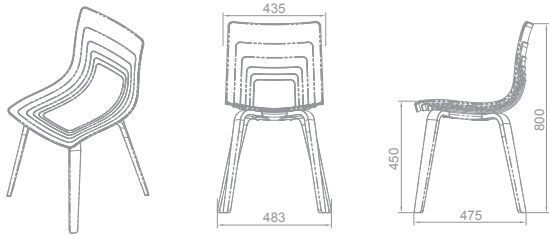

## 5-WAVES CHAIR

Solid wood base chair  
5W-3SW-PP

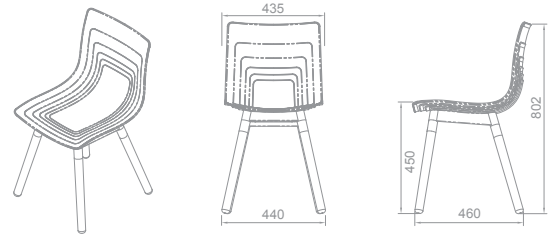

## 5-WAVES CHAIR

Stackable High stool  
5W-1H-PP

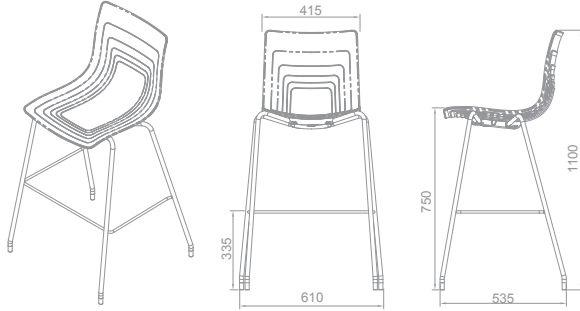

## 4-WAVES CHAIR

Sled base High stool  
4W-2H-PP

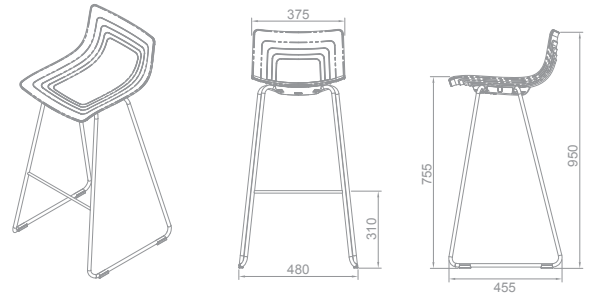

## 4-WAVES CHAIR

Circular base High stool  
4W-5H-PP

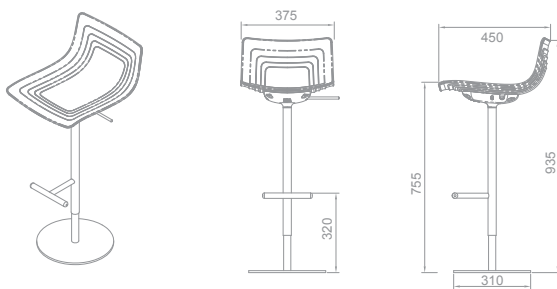

## 4-WAVES CHAIR

High stool  
4W-1H-PP

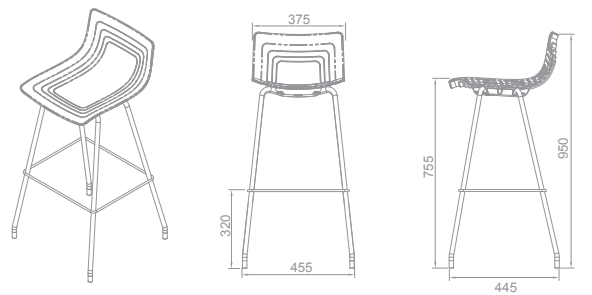

## 6-WAVES CHAIR

Four legs chair  
6W-1-PP

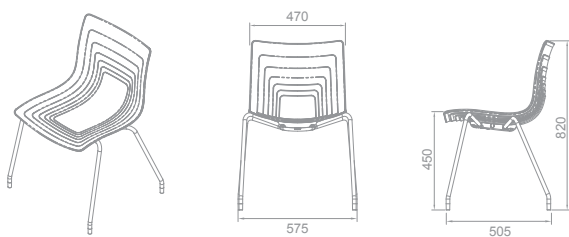

## 6-WAVES CHAIR

Four legs chair with armrest  
6W-1L-PP

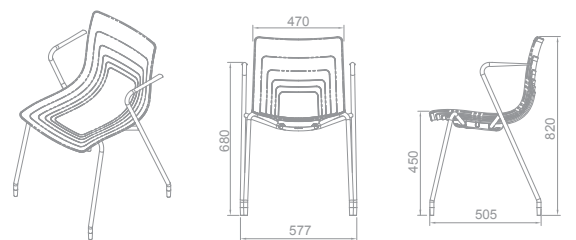

# The Collection

## 6-WAVES CHAIR

Four legs chair with casters  
6W-1C-PP

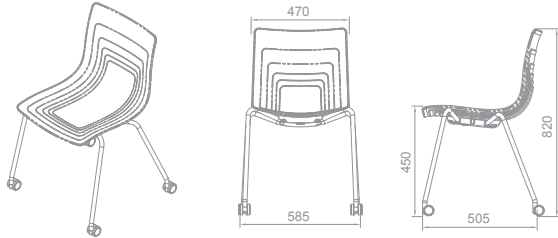

## 6-WAVES CHAIR

Four legs chair with writing tablet  
6W-1-PP+WR

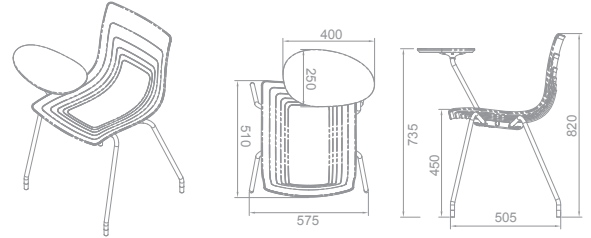

## 6-WAVES CHAIR

Sled base chair  
5W-2-PP

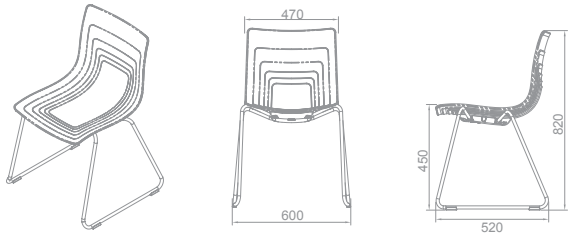

## 6-WAVES CHAIR

Sled base chair with armrest  
5W-2L-PP

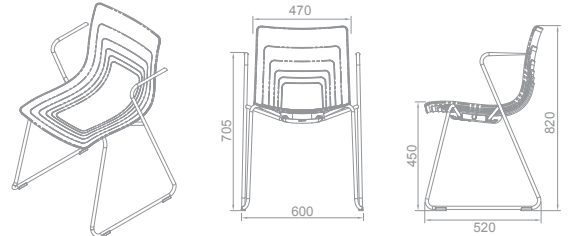

## 6-WAVES CHAIR

Swivel base with casters  
6W-4-PP-AP1

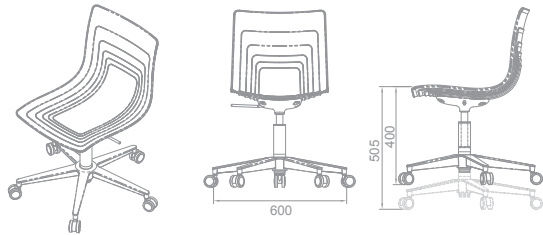

## 6-WAVES CHAIR

Swivel base with casters and arm  
6W-4L-PP-AP1

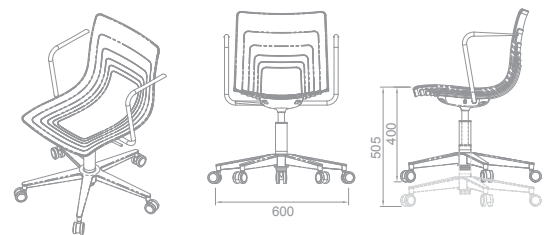

## Shell Colours



W01 Black    W02 White    W03 Gray    W04 Lt. Green    W05 Red

## Frame Colours



W01 Black    W02 White    W03 Gray    W04 Lt. Green    W05 Red    W06 Chrome



**harvest  
one**

**No.42, 37th Road,  
Taichung Industrial Park  
Taichung, Taiwan  
Tel : 886-4-23580698  
Fax : 886-4-23504897**

**mail: [info@harvest-one.com](mailto:info@harvest-one.com)  
[www.harvest-one.net](http://www.harvest-one.net)  
[www.harvestlink.com](http://www.harvestlink.com)**